

MESA CHAIRS & TABLE SET #8705

MESA *Chairs & Table Set*

Made with 100% FSC® Certified Outdoor Lumber



Thank you for purchasing the **MESA Chairs & Table Set!**

For further inquiries or additional information, kindly reach out:

customerservice@gomayne.com

Toll Free Phone: 1-866-363-8834

INSTRUCTIONS:

- Read through all instructions before beginning assembly.
- Inspect all the pieces to ensure you have everything you need.
- Manual assembly recommended. If using a power drill, reduce torque setting and be careful not to over-tighten.
- Assemble chair on a clean, smooth surface to avoid scratching the product.
- Save all packaging until finished.

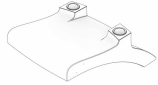

1 Seat (1)
#MP8701



2 Backrest (1)
#MCP8702



A Left Leg (1)
#MC2003GY



B Cross Brace (1)
#MC2006GY



C Right Leg (1)
#MC2002GY



D Arm Rest (2)
#MC2001GY



E Bolt (4)
M6x40mm
#MC1113



F Wood Screw (12)
M5x45mm
#MC1109



G Bolt (2)
M6x30mm
#MC1112



H Bolt (4)
M6x60mm
#MC1111



I Adjustable Feet (4)
M6x14mm
#MC1201



J Gasket (2)
#MC1202



K Caps (4)
#MC1217

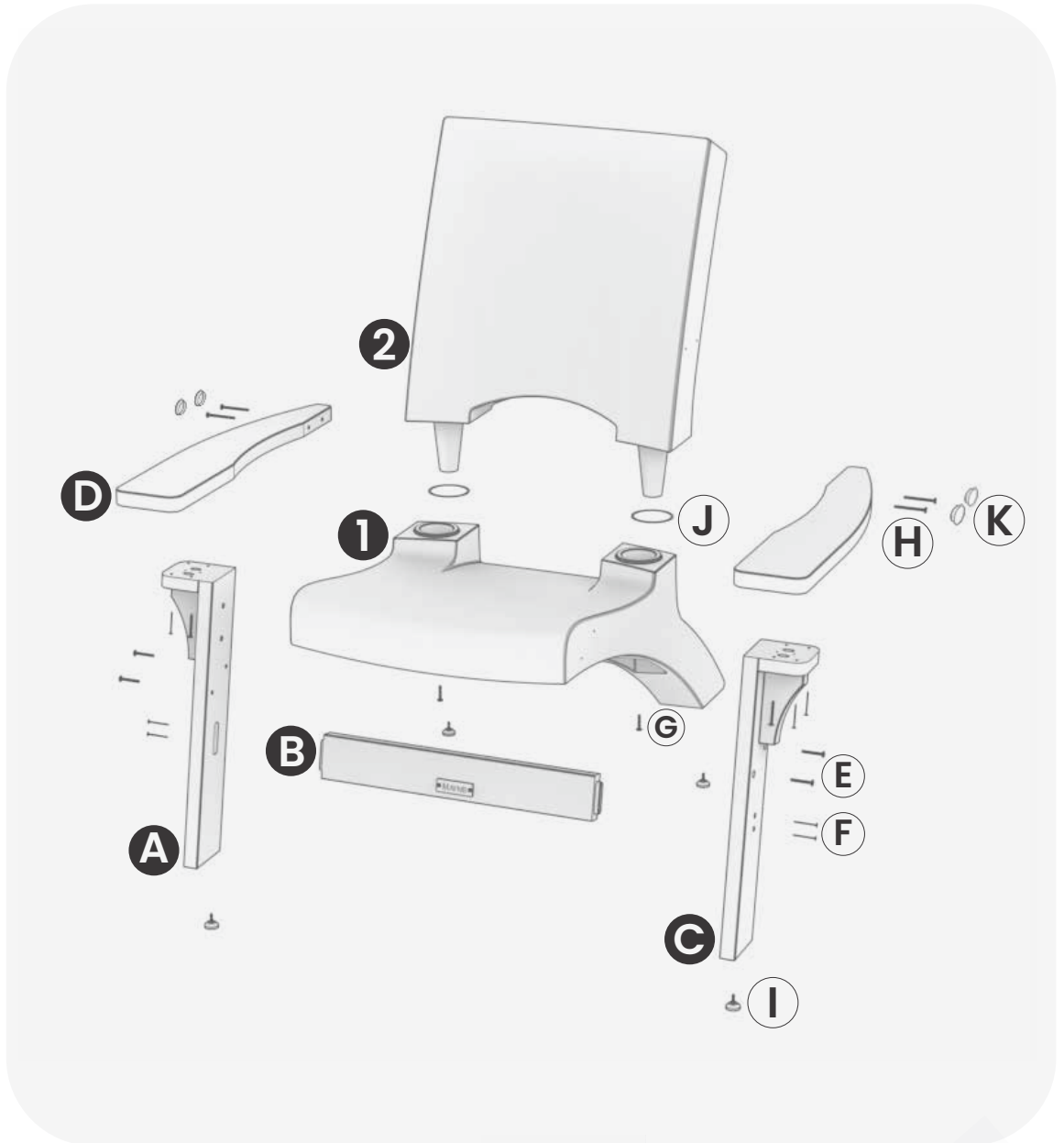

Tools Needed:



Phillip Screwdriver
Bit #2
(for wood screws)



Phillip Screwdriver
Bit #3
(for bolts)



Power Drill
(optional)

- 1** Place the chair seat sideways as shown below. Attach the Right Leg (**part C**) to seat using 2 - M6x40mm bolts (**part E**).

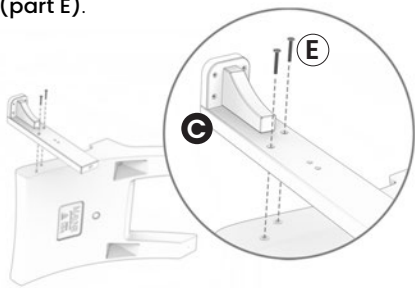

- 2** Tilt the chair upward slightly to slide in the cross brace (**part B**) into the slot in the leg. Secure in place using 2 - M5x45mm wood screws (**part F**).

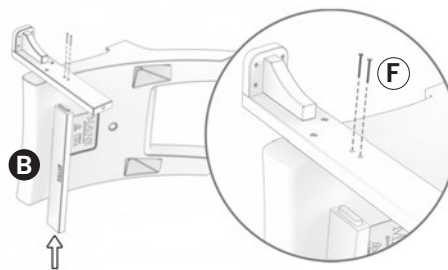

- 3** Turn the chair over to the opposite side to attach the Left Leg (**part A**) using 2 - M6x40mm bolts (**part E**). Be sure to align the cross brace with the slot in the left leg. Next, secure the leg to the cross brace with 2 - M5x45mm wood screws (**part F**).

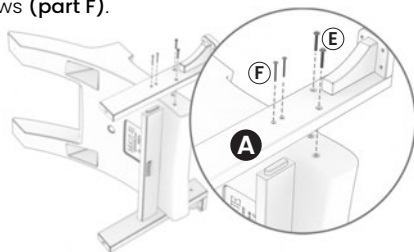

- 4** Set the chair in upright position and place two gaskets (**part J**) on the flanges of the seat. Insert the backrest (**part 2**) into the slots in the seat ensuring the gaskets remain centered.

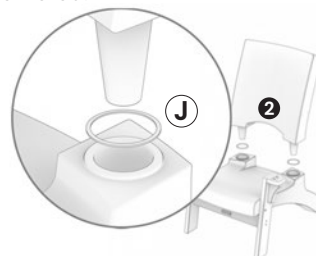

- 5** Keep the backrest firmly pressed in position and carefully rotate the chair upside down. Ensure the backrest is firmly in place and install 2 - M6x30mm bolts (**part G**).

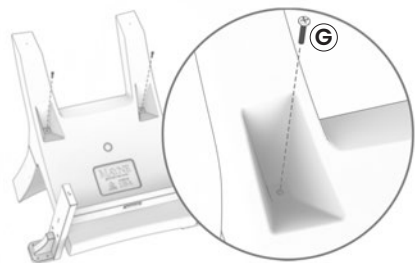

- 6** Place the chair in upright position and install arm rest (**part D**) on the right side of the chair. Secure arm to backrest with 2 - M6x60mm bolts (**part H**). Tip: Get the threading started with both bolts before tightening.

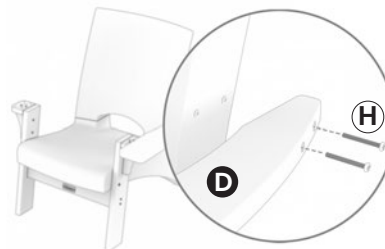

- 7** Before attaching the arm rest to the leg, ensure the inside face of the arm is flush with the inside face of the leg. Secure arm to leg with 4 - M5x45mm wood screws (**part F**).

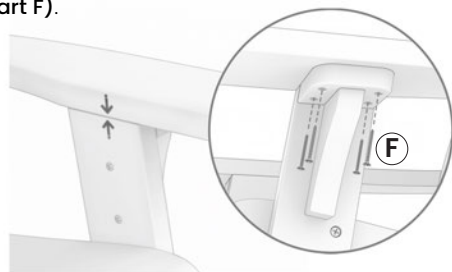

- 8** Repeat steps 6 & 7 on the left side of the chair.

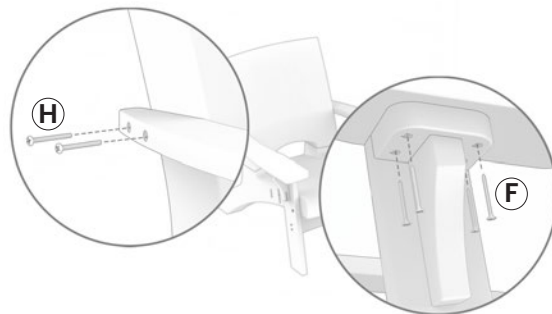

- 9** Install the caps (**part K**) to cover up recessed holes on both arm rests (**part D**).

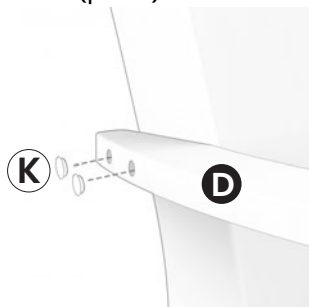



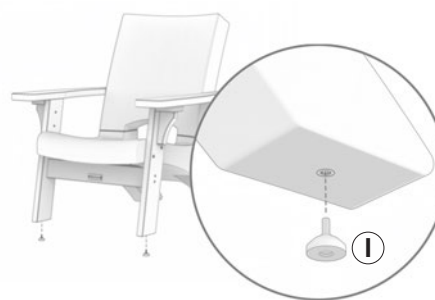

- 10** Install the adjustable feet (**part I**) in the bottom of each leg.



INSTRUCTIONS:

- Read through all instructions before beginning assembly.
- Inspect all the pieces to ensure you have everything you need.
- Manual assembly recommended. However, a power drill will be required for Step 6. Be sure to reduce the torque setting and be careful not to over-tighten.
- Assemble side table on a clean, smooth surface to avoid scratching the product.
- Save all packaging until finished.

-  **A** Leg A (2)
#MC2012GY
-  **B** Leg B (2)
#MC2013GY
-  **C** Support Panel w/ Logo (1)
#MC2009GY
-  **D** Support Panel (1)
#MC20010GY
-  **E** Shelf (2)
#MC2011GY

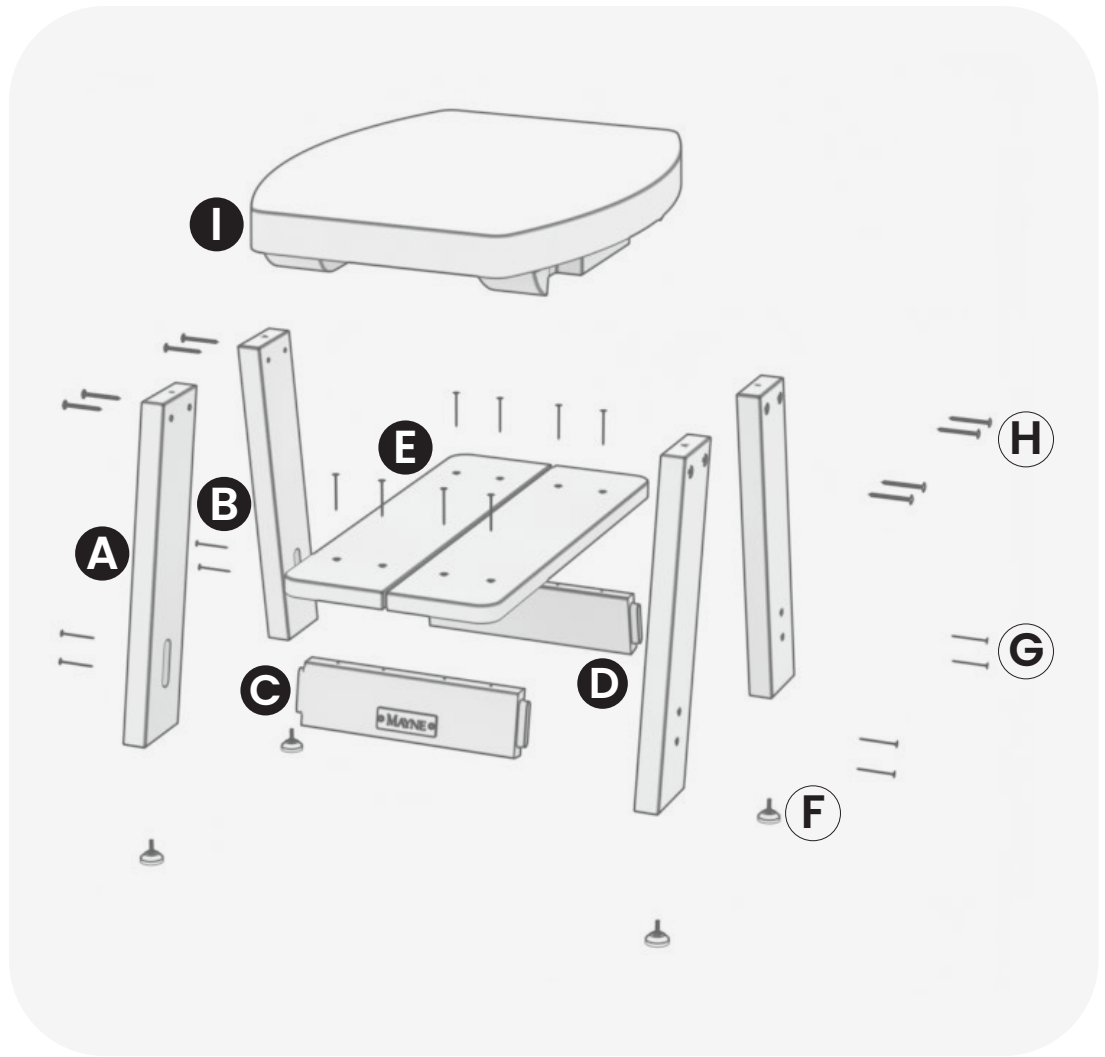

-  **F** Adjustable Feet (4)
M6x14mm
#MC1201
-  **G** Wood Screw (16)
M5x45mm
#MC1109
-  **H** Truss Screw (8)
M6x50mm
#MC1114
-  **I** Tabletop (1)
#MP8704

Tools Needed:

-  Phillip Screwdriver
Bit #2
(for wood screws)
-  Phillip Screwdriver
Bit #3
(for truss screws)
-  Power Drill

1 Attach Legs (**part A and B**) to the Support Panel (**part C**) using 4 - M5x45mm wood screws (**part G**). Make sure the logo faces outward and pre-drilled holes face upward as shown. Top surface of cross support should be aligned parallel with the top and bottom surface of the legs.

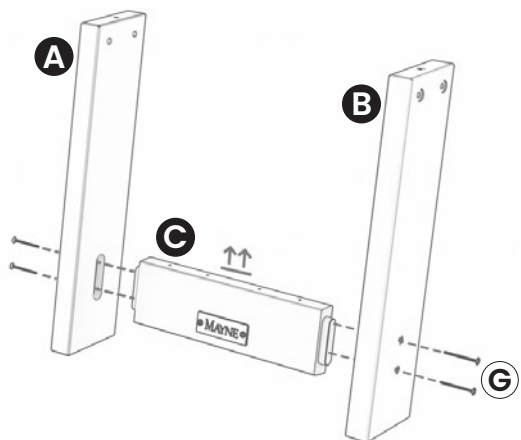

2 Repeat for the other side using the Support Panel without the logo (**part D**).

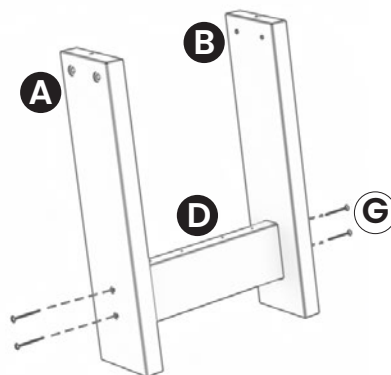

3 With 2 - M5x45mm wood screws (**part G**), attach one shelf (**part E**) to the first leg assembly. Align the pre-drilled holes as shown ensuring the counter sunk feature is facing upward. Underside of the shelf is labelled "bottom".

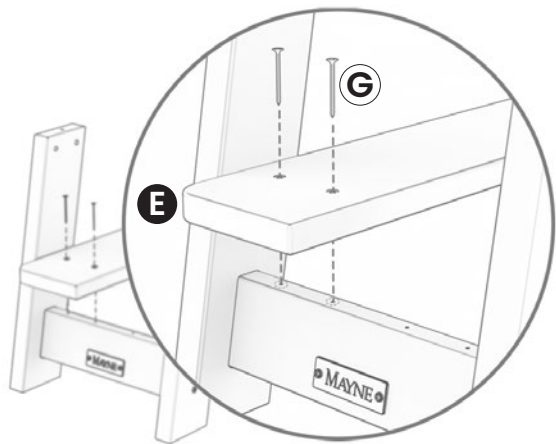

4 Repeat Step 3 to attach the shelf to the second leg assembly.

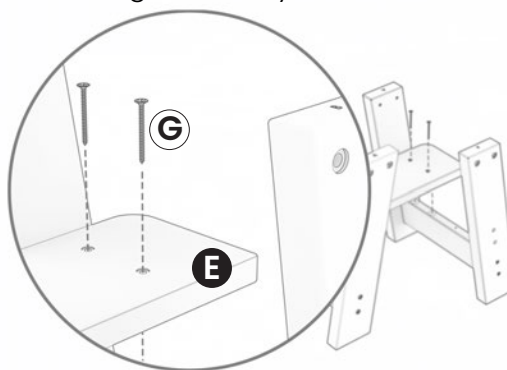

5 Add the second shelf (**part E**) and secure it with 4 - M5x45mm wood screws (**part G**).

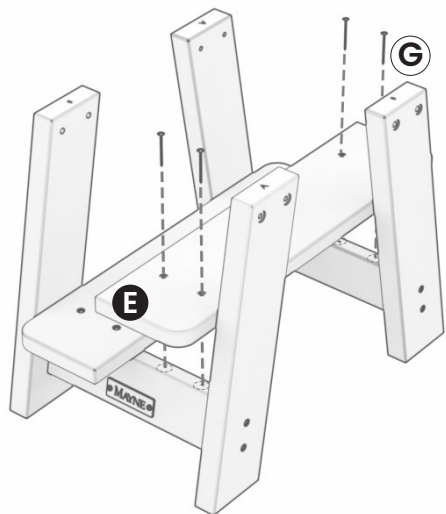

6 Attach the table top (**part I**) to the leg assembly with M6x50mm truss screws (**part H**). Install two truss screws per leg. There are no pre-drilled holes in the table; however, the screws will self-tap into the plastic.

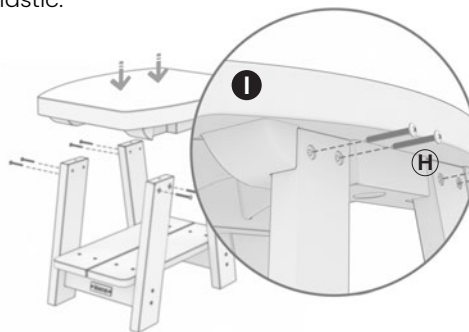

7 Install the adjustable feet (**part F**) in the bottom of each leg.

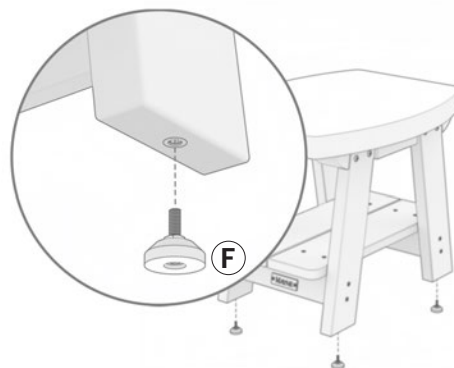

MESA CHAIRS & TABLE SET #8705

The **MESA Chairs and Table Set** is designed for year-round use and built to last. Extend the life of the table and keep it looking new by treating the wood components yearly with a water-based wood stain or sealant designed for exterior use.

GENERAL INFORMATION ABOUT THE MATERIALS:

WOOD: The wood components provided with your MESA product are made from 100% FSC Certified Cedar and come with a protective water-based stain. The Cedar is resilient and intended for year-round use in all climates.

Please Note: With any natural wood product, it is common to see knots, small checks (cracks), minor warping, and fading as part of the weathering process. These minor imperfections occur naturally and have no impact on the strength or integrity of the product.

POLYETHYLENE: The resin components provided with your MESA product are molded from high-quality polyethylene (LLDPE). This material is extremely durable and is also intended for year-round use in all climates.

PRODUCT MAINTENANCE:

WOOD: The cedar components are pre-stained at the factory but exposure to sunlight will break down the water repellent, reducing the effectiveness. To extend the life of your product, we recommend staining the wood components on an annual basis. If products will be exposed to harsh weather for prolonged periods of time, we recommend covering when not in use for added protection.

POLYETHYLENE: Clean using a non-abrasive cleaner and cloth, then simply rinse with a garden hose. For deeper cleaning you can use a power washer; however, be careful to only spray the polyethylene surfaces and do not pressure wash the wood as this will deteriorate the protective stain.

HARDWARE: Inspect screws and bolts annually for signs of rust. If rust is present, sand and repaint or replace if necessary.

SAFE USE RECOMMENDATIONS:

- Inspect wood for splinters and sand smooth before use.
- Ensure all hardware is firmly tightened before using product, being careful not to overtighten since this could cause crushing and splintering of the wood.
- Wood is not flame retardant and will burn. Do not place furniture too close to fire pits or open flames. Caution should be used if placed in proximity to fire pits or open flames.
- Use product on a level surface. Adjustable feet are included to assist with minor leveling adjustments.

LIMITED WARRANTY:

- Mayne products are covered by a warranty that safeguards against defects in materials, manufacturing, and workmanship. This warranty is exclusive to the original owner and is non-transferable. To validate any warranty claims, proof of purchase and regular maintenance are essential.

Hardware – 1 Year

Wood Components – 5 Years

Resin Components – 15 Years

This Limited Warranty does not cover:

- Labor for replacement of any defective item(s)
- Incidental or consequential damages
- Cosmetic defects which do not affect performance or integrity
- Vandalism; improper use or installation, or acts of nature including but not limited to windstorms, hail, floods, excessive water exposure or damage by animals/wildlife

Warranty claims may be submitted by providing photos of the defect along with proof of purchase to customerservice@gomayne.com.

MAYNE®

gomayne.com

7024 Kilbourne Rd Unit A

London, ON N6P 1K6

